

BrouTec

meubelbeslag

LADEN / GELEIDERS

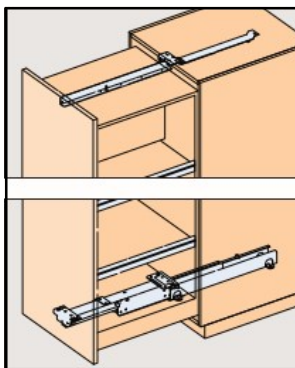

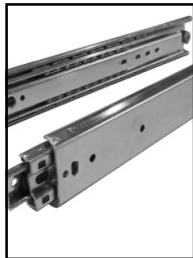
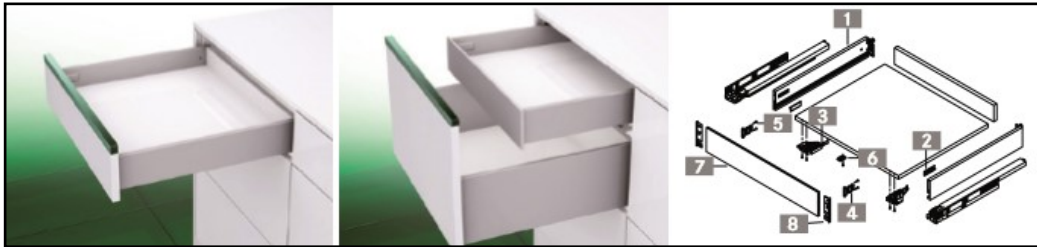

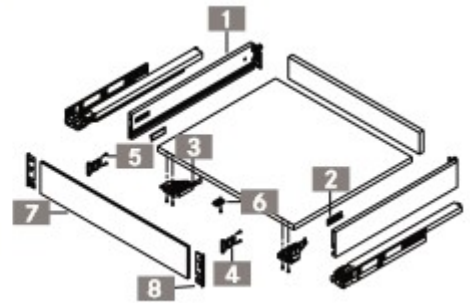

Email: info@broutec.nl www.broutec.nl Tel: 0031 (0)573 454242

VIONARO

Lade in staal grafiet hoogte 89 mm



| OMSCHRIJVING | NOMINALE LENGTE | CODE | OMSCHRIJVING | UITVOERING | CODE |
|---|--|---|---|---|------------------------|
| 1 Ladezijwand in grafiet. | 270 mm 300 mm 350 mm 400 mm 450 mm 500 mm 550 mm 600 mm 650 mm | 5300-1527 5300-1530 5300-1535 5300-1540 5300-1545 5300-1550 5300-1555 5300-1560 5300-1565 | 2 Afdekkap binnen. | grafiet | 5300-1090 |
|  | | |  2 st. bestellen per frontlade. | | |
| | | | OMSCHRIJVING | | CODE |
| | | | 6 Front-bodemverbinder. |  | 5300-1075 |
| OMSCHRIJVING | | CODE | OMSCHRIJVING | SOORT MONTAGE | CODE |
| 3 Koppeling links/rechts. | | 5300-1030 | 4 Frontbevestiging. | om op te schroeven met drevels | 5300-1010 5300-1020 |
|  | | |  | | |





EXTRA TE BESTELLEN VOOR EEN BINNENLADE

| OMSCHRIJVING | UITVOERING | CODE | OMSCHRIJVING | CODE |
|--|-------------------|-------------------|--|-------------------|
| 5 Schroef. | ∅ 4 x 11,5 mm | 5300-1080 | 6 Front-bodemverbinder. | 5300-1070 |
|  4 st. bestellen per binnenlade voor frontbevestiging. | | |  | |
| 7 Front in grafiet. Hoogte 89 mm om op maat te zagen, zonder eindkappen. | LENGTE 1160 mm | CODE 5300-1580 | 8 Afdekkap voor front. | CODE 5300-1590 |
|  | | |  2 st. bestellen per binnenlade. | |

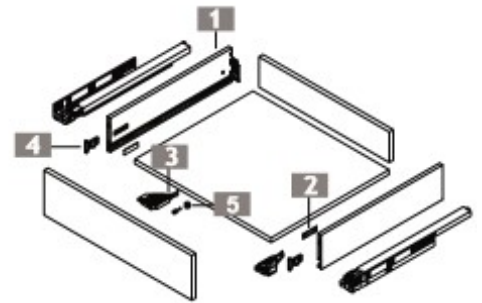
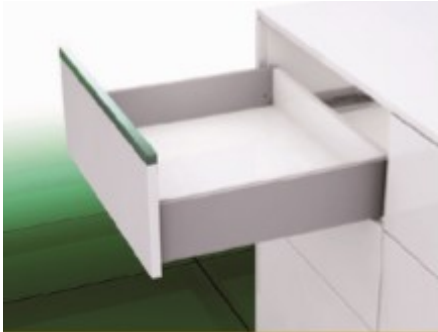
VIONARO

Lade in staal grafiet, hoogte **121 mm**







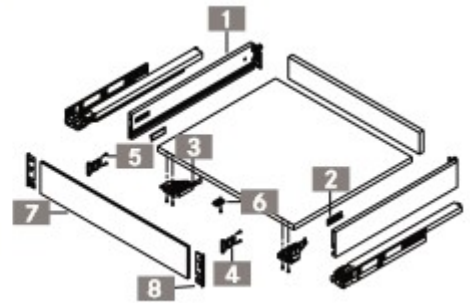

| | | | | | |
|---|---|---|--|--|------------------------------|
| <p>1 Ladezijwand in grafiet.</p>  | <p>NOMINALE LENGTE</p> <p>400 mm 450 mm 500 mm 550 mm</p> | <p>CODE</p> <p>5300-1840 5300-1845 5300-1850 5300-1855</p> | <p>2 Afdekkap binnen.</p>  <p>2 st. bestellen per frontlade.</p> | <p>UITVOERING</p> <p>grafiet</p> | <p>CODE</p> <p>5300-1090</p> |
| | | <p>5 Front-bodemverbinder.</p>  | | <p>CODE</p> <p>5300-1075</p> | |
| <p>3 Koppeling links/rechts.</p>  | <p>CODE</p> <p>5300-1030</p> | <p>4 Frontbevestiging.</p>  | <p>SOORT MONTAGE</p> <p>om op te schroeven met drevels</p> | <p>CODE</p> <p>5300-1010 5300-1020</p> | |





VIONARO

Lade in staal grafiet hoogte **185 mm**



| OMSCHRIJVING | NOMINALE LENGTE | CODE | OMSCHRIJVING | UITVOERING | CODE |
|---|--|---|---|------------|-----------|
| 1 Ladezijwand in grafiet. | 270 mm 300 mm 350 mm 400 mm 450 mm 500 mm 550 mm 600 mm 650 mm | 5300-1627 5300-1630 5300-1635 5300-1640 5300-1645 5300-1650 5300-1655 5300-1660 5300-1665 | 2 Afdekkap binnen. | grafiet | 5300-1090 |
|  | | |  2 st. bestellen per frontlade. | | |
| | | | OMSCHRIJVING | | CODE |
| | | | 7  Front-bodemverbinder. | | 5300-1075 |
| | | | OMSCHRIJVING | | CODE |
| | | | 3  Koppeling links/rechts. | | 5300-1030 |
| | | | | | |
| OMSCHRIJVING | SOORT MONTAGE | CODE | OMSCHRIJVING | UITVOERING | CODE |
| 4 Frontbevestiging. | om op te schroeven met drevels | 5300-1010 5300-1020 | 5 Frontstabilisator. | ø 10 mm | 5300-1040 |
|  | | |  2 st. bestellen per frontlade. | | |

EXTRA TE BESTELLEN VOOR EEN BINNENLADE

| OMSCHRIJVING | CODE | OMSCHRIJVING | CODE | |
|--|---------------|---|--|-----------|
| 5 Frontstabilisator. | 5300-1045 | 7 Front-bodemverbinder. | 5300-1070 | |
|  2 st. bestellen per binnenlade. | |  | | |
| OMSCHRIJVING | UITVOERING | CODE | | |
| 6 Schroef. | ø 4 x 11,5 mm | 5300-1080 | | |
|  4 st. bestellen per binnenlade voor frontbevestiging. | | | | |
| OMSCHRIJVING | LENGTE | CODE | OMSCHRIJVING | CODE |
| 8 Front in grafiet. Hoogte 185 mm om op maat te zagen, zonder eindkappen. | 1160 mm | 5300-1685 | 9 Afdekkap voor front. | 5300-1595 |
|  | | |  2 st. bestellen per binnenlade. | |

VIONARO

Technische tekeningen

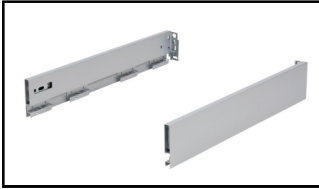

VIONARO hoog 89 mm

Binnenbreedte kast
Rugwandbreedte = Binnenbreedte kast - 42 mm

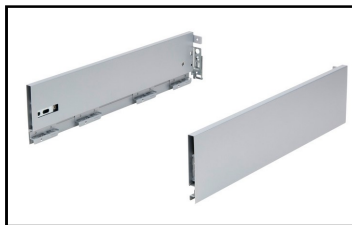
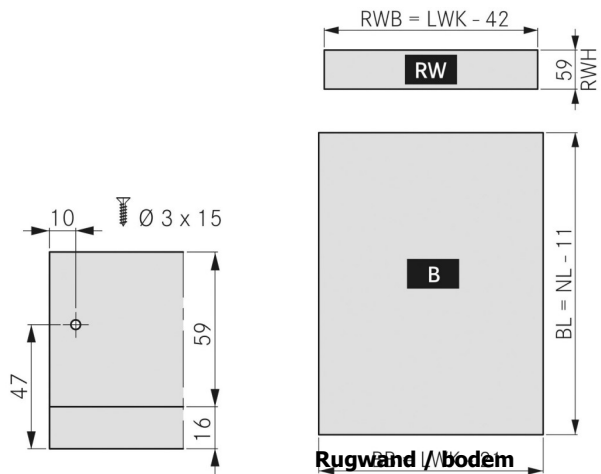
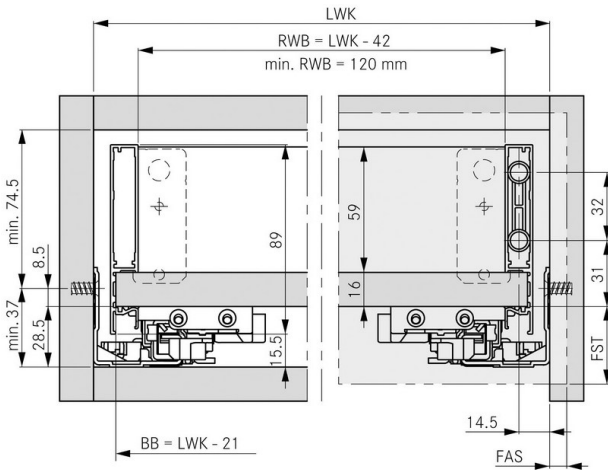

VIONARO hoog 121 mm

Binnenbreedte kast
Rugwandbreedte = Binnenbreedte kast - 42 mm

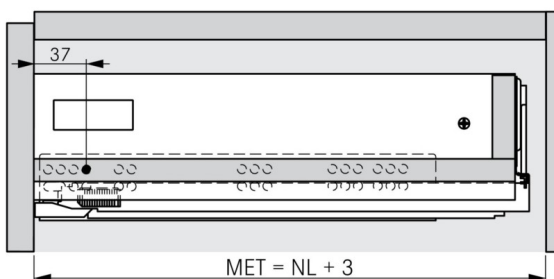
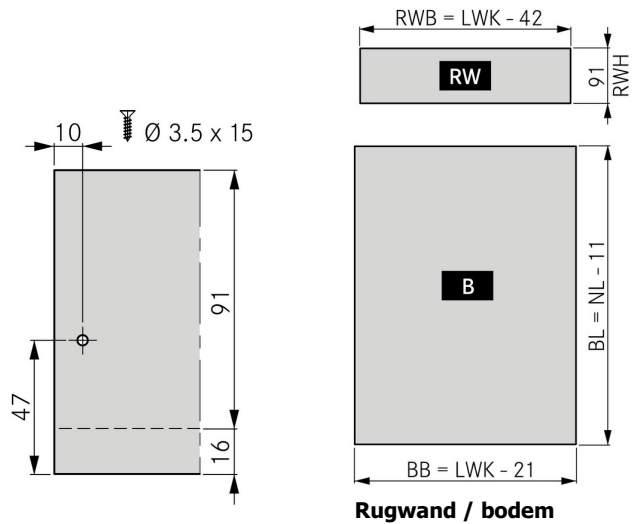
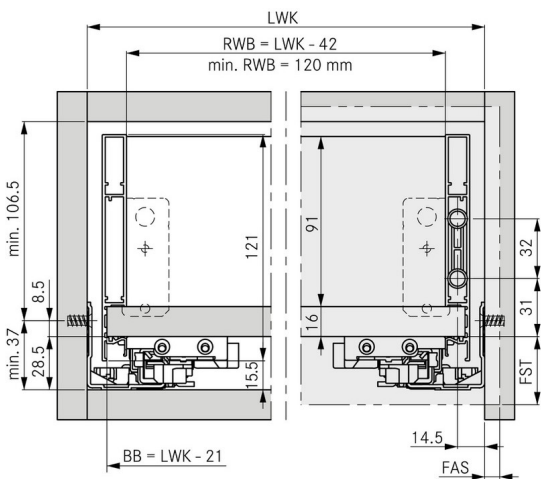

VIONARO

Technische tekeningen



VIONARO hoog 185 mm

Binnenbreedte kast
Rugwandbreedte = Binnenbreedte kast - 42 mm

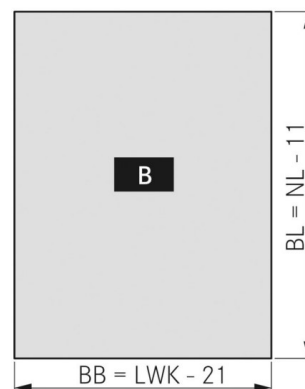
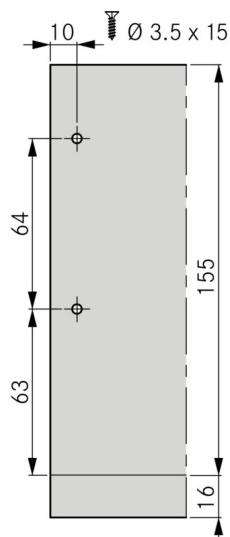
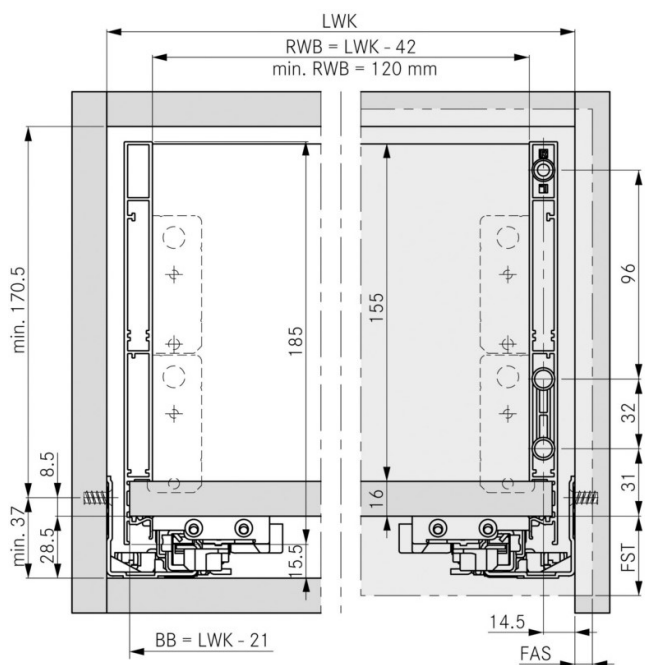



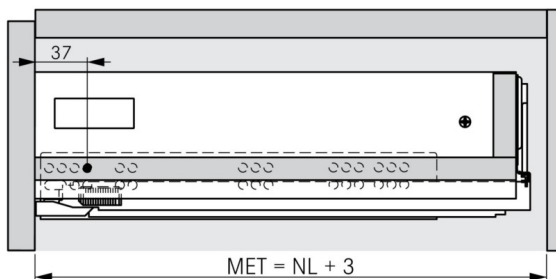



Rugwand / bodem

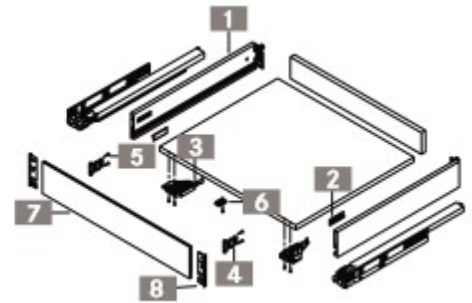

VIONARO

Lade in staal grijs hoogte **89 mm**

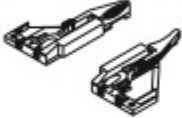

| OMSCHRIJVING | NOMINALE LENGTE | CODE | OMSCHRIJVING | UITVOERING | CODE |
|---|--|---|---|---|------------------------|
| 1 Ladezijwand. | 270 mm 300 mm 350 mm 400 mm 450 mm 500 mm 550 mm 600 mm 650 mm | 5300-1327 5300-1330 5300-1335 5300-1340 5300-1345 5300-1350 5300-1355 5300-1360 5300-1365 | 2 Afdekkap binnen. | grijs | 5300-1050 |
|  | | |  2 st. bestellen per frontlade. | | |
| | | | OMSCHRIJVING | | CODE |
| | | | 6 Front-bodemverbinder. |  | 5300-1075 |
| OMSCHRIJVING | | CODE | OMSCHRIJVING | | CODE |
| 3 Koppeling links/rechts. | | 5300-1030 | 4 Frontbevestiging. | om op te schroeven met drevels | 5300-1010 5300-1020 |
|  | | |  | | |





EXTRA TE BESTELLEN VOOR EEN BINNENLADE

| OMSCHRIJVING | UITVOERING | CODE | OMSCHRIJVING | CODE |
|---|---------------|---------------|--|-------------|
| 5 Schroef. | ∅ 4 x 11,5 mm | 5300-1080 | 6 Front-bodemverbinder. | 5300-1070 |
|  4 st. bestellen per binnenlade voor fontbevestiging. | | |  | |
| OMSCHRIJVING | | LENGTE | OMSCHRIJVING | CODE |
| 7 Front hoogte 89 mm om op maat te zagen, zonder eindkappen. | 1160 mm | 5300-1380 | 8 Afdekkap voor front. | 5300-1190 |
|  | | |  2 st. bestellen per binnenlade. | |

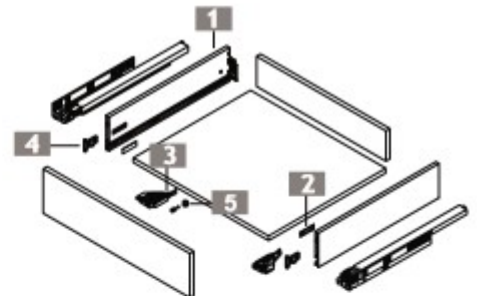
VIONARO

Lade in staal grijs, hoogte **121 mm**

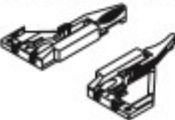





| | | | | | |
|--|---|--|---|--|--|
| <p>1 OMSCHRIJVING Ladezijwand.</p>  | <p>NOMINALE LENGTE</p> <p>400 mm 450 mm 500 mm 550 mm</p> | <p>CODE</p> <p>5300-1740 5300-1745 5300-1750 5300-1755</p> | <p>2 OMSCHRIJVING Afdekkap binnen.</p>  <p>2 st. bestellen per frontlade.</p> | <p>UITVOERING</p> <p>grijs</p> | <p>CODE</p> <p>5300-1050</p> |
| | | | <p>OMSCHRIJVING</p> <p>5 Front-bodemverbinder.</p>  | <p>CODE</p> <p>5300-1075</p> | |
| <p>3 OMSCHRIJVING Koppeling links/rechts.</p>  | <p>CODE</p> <p>5300-1030</p> | | <p>4 OMSCHRIJVING Frontbevestiging.</p>  | <p>SOORT MONTAGE</p> <p>om op te schroeven met drevels</p> | <p>CODE</p> <p>5300-1010 5300-1020</p> |





VIONARO

Lade in staal grijs, hoogte **185 mm**



| OMSCHRIJVING | NOMINALE LENGTE | CODE | OMSCHRIJVING | UITVOERING | CODE |
|---|--|---|---|------------|-----------|
| 1 Ladezijwand. | 270 mm 300 mm 350 mm 400 mm 450 mm 500 mm 550 mm 600 mm 650 mm | 5300-1427 5300-1430 5300-1435 5300-1440 5300-1445 5300-1450 5300-1455 5300-1460 5300-1465 | 2 Afdekkap binnen. | grijs | 5300-1050 |
|  | | |  2 st. bestellen per frontlade. | | |
| | | | OMSCHRIJVING | | CODE |
| | | | 7 Front-bodemverbinder. | | 5300-1075 |
| | | | OMSCHRIJVING | | CODE |
| | | | 3 Koppeling links/rechts. | | 5300-1030 |
| | | | OMSCHRIJVING | | CODE |
| 4 Frontbevestiging. | SOORT MONTAGE | CODE | 5 Frontstabilisator. | UITVOERING | CODE |
|  | om op te schroeven met drevels | 5300-1010 5300-1020 |  2 st. bestellen per frontlade. | ø 10 mm | 5300-1040 |

EXTRA TE BESTELLEN VOOR EEN BINNENLADE

| OMSCHRIJVING | CODE | OMSCHRIJVING | CODE |
|--|-----------------------------|--|-----------|
| 5 Frontstabilisator. | 5300-1045 | 7 Front-bodemverbinder. | 5300-1070 |
|  2 st. bestellen per binnenlade. | |  | |
| 6 Schroef. | 5300-1080 | | |
|  4 st. bestellen per binnenlade voor frontbevestiging. | UITVOERING ø 4 x 11,5 mm | | |
| 8 Front hoogte 185 mm om op maat te zagen, zonder eindkappen. | LENGTE 1160 mm | 9 Afdekkap voor front. | 5300-1195 |
|  | CODE 5300-1480 |  2 st. bestellen per binnenlade. | |

VIONARO

Geleiders Softclose / Tipmatic



| OMSCHRIJVING | NOM. LGT. | SOFT-CLOSE | | | TIPMATIC | | |
|---|-----------|-------------|--------|-----------|-------------|-----------|--|
| | | DRAAGKRACHT | | | DRAAGKRACHT | | |
| | | 40 KG | 60 KG | 70 KG | 40 KG | 60 KG | |
| Geleider DYNAPRO voor KEUKENLADE VIONARO volledig uittrekbaar MET SOFT-CLOSE OF MET GEÏNTEGREERDE TIPMATIC. <ul style="list-style-type: none"> • regelbare hoogteverstelling + 3,5 mm • regelbare zijdeverstelling +/- 1,5 mm • frontverstelling + 4 mm | 270 mm | C10447 | - | - | - | - | |
| | 300 mm | C10441 | - | - | 5300-0330 | - | |
| | 350 mm | C10442 | - | - | 5300-0335 | - | |
| | 400 mm | C10443 | - | - | 5300-0340 | - | |
| | 450 mm | C10444 | C10470 | 5300-0745 | 5300-0345 | 5300-0445 | |
| | 500 mm | C10445 | C10471 | 5300-0750 | 5300-0350 | 5300-0450 | |
| | 550 mm | C10446 | C10472 | 5300-0755 | 5300-0355 | 5300-0455 | |
| | 600 mm | C10459 | C10473 | 5300-0760 | - | 5300-0460 | |
| | 650 mm | - | C10474 | 5300-0765 | - | 5300-0465 | |
| | | | | | | | |

OPTIONEEL - TIPMATIC VANAF KORPUS 600 MM

| OMSCHRIJVING | UITVOERING | CODE | OMSCHRIJVING | CODE |
|--------------------------|------------------|------------------------|-------------------------|--------|
| Synchronisatieset | 40 kg. 60 kg. | 5300-0300 5300-0400 | Verbindingsstang | B38089 |

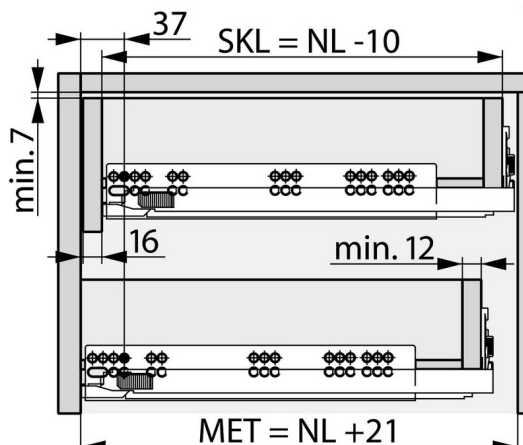

DWD Keukenlade 95 mm

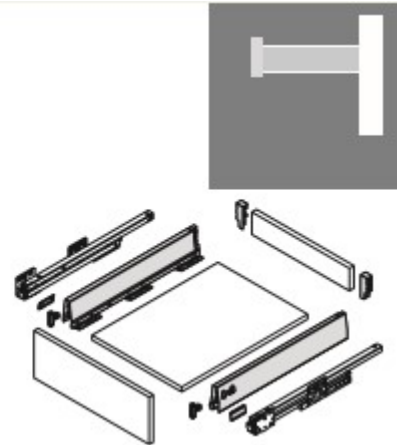

**Dubbelzijdige metalen lade hoog 95 mm.
Geschikt voor houten of metalen rugwand.**

1

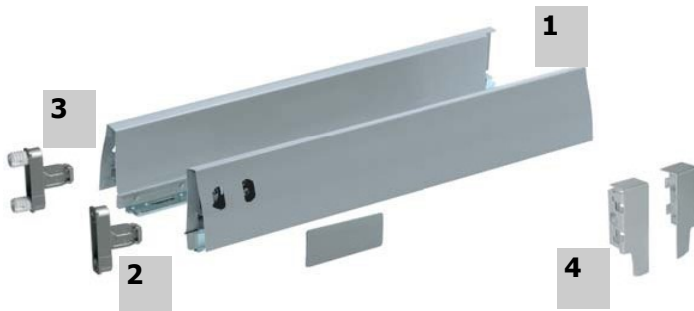

2

Frontbevestiging om te schroeven

30 B38010

3

Frontbevestiging met deugel

30 B38011

Maten van de rugwand en bodem in plaat dikte van 16 mm

4

Rugwand houder voor hout 95 mm

30 B38015

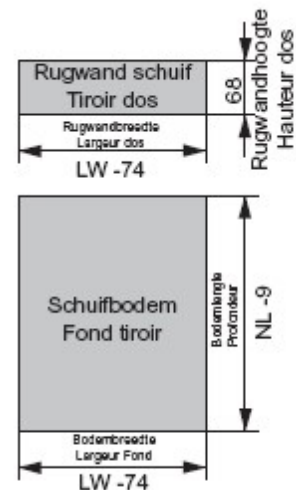
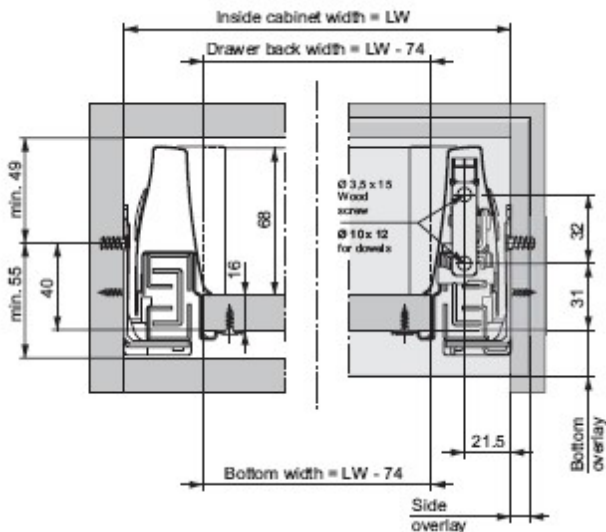

DWD Voorraadlade 175 mm

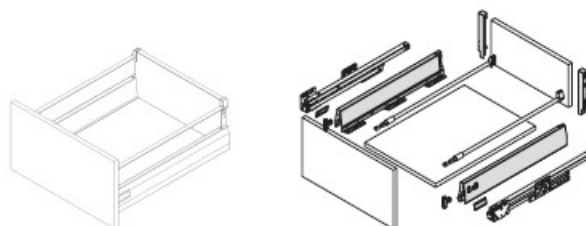

**Dubbelzijdige metalenlade voor voorraadlade
hoog 175 mm.
Geschikt voor houten of metalen rugwand.**

| 1 | Diepte mm | Bestelcode |
|---|-----------|------------------|
| | 275 | 30 B38000 |
| | 350 | 30 B38001 |
| | 400 | 30 B38002 |
| | 450 | 30 B38003 |
| | 500 | 30 B38004 |
| | 550 | 30 B38005 |
| | 600 | 30 B38006 |
| | 650 | 30 B38007 |

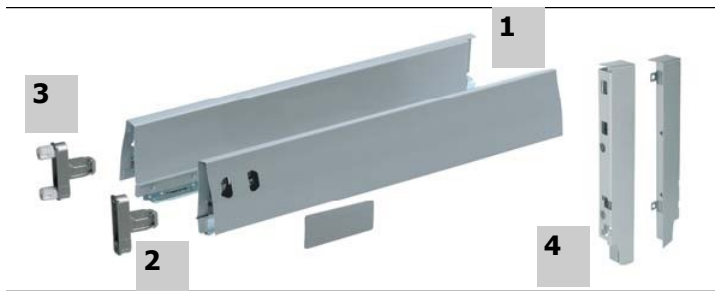

| | | |
|---|--|------------------|
| 2 | Frontbevestiging om te schroeven. | 30 B38010 |
| 3 | Frontbevestiging met deugel. | 30 B38011 |
| 4 | Rugwand houder Voor hout 182 mm. | 30 B38016 |

Maten van de rugwand en bodem in plaat dikte van 16 mm.

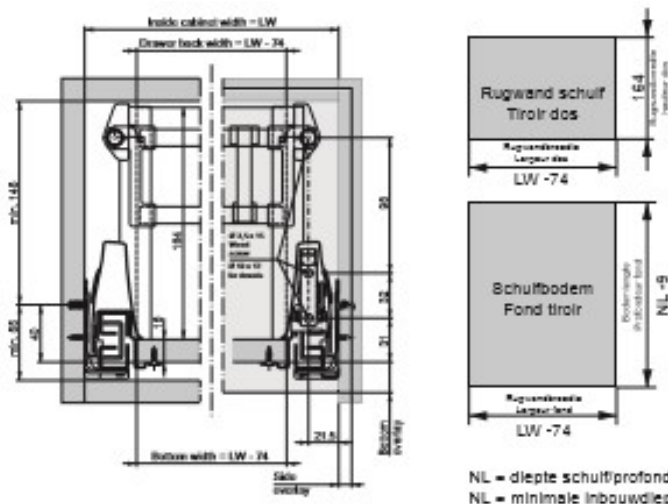

DWD Side-wing en verdelingsset

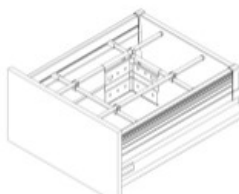

| 1 | lengte mm | Bestelcode |
|---|-----------|------------------|
| | 400 | 30 B38112 |
| | 450 | 30 B38113 |
| | 500 | 30 B38114 |
| | 550 | 30 B38115 |
| | 600 | 30 B38116 |
| | 650 | 30 B38117 |



| 2 | Verdelingsset zilverkleur. Corpus breedte - diepte | | |
|---|---|-----|------------------|
| | 600 | 500 | 30 B38118 |
| | 1200 | 500 | 30 B38119 |

| 3 | Smart board zilverkleur. | 30 B38109 |
|---|--------------------------|------------------|
|---|--------------------------|------------------|

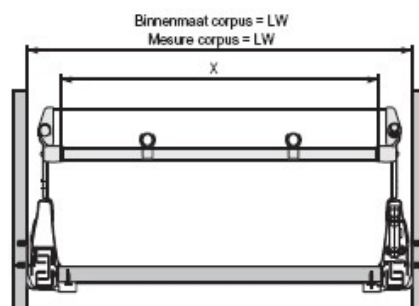

Dwarsverdeling X = LW - 92
Séparation latérale X = LW - 92

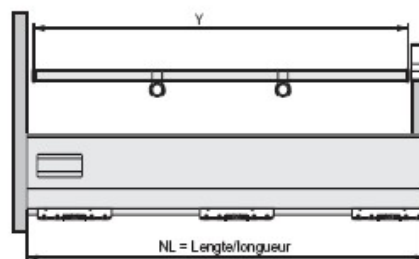

Lengteverdeling/Séparation longueur
Y = NL - 38

DWD
Opschroef reling

Toebehoren DWD



Opschroef reling DWD XP zilver per paar.
Geschikt voor houten als bij metalen rugwand.

1

| Diepte mm | Bestelcode |
|-----------|------------------|
| 275 | 30 B38130 |
| 350 | 30 B38131 |
| 400 | 30 B38132 |
| 450 | 30 B38133 |
| 500 | 30 B38134 |
| 550 | 30 B38135 |
| 600 | 30 B38136 |
| 650 | 30 B38137 |



2



2

Reling houder voor
hoge rugwanden.

30 B38014

DWD Binnenlade toebehoren



Front voor binnenlade en front voor pannen binnenlade.

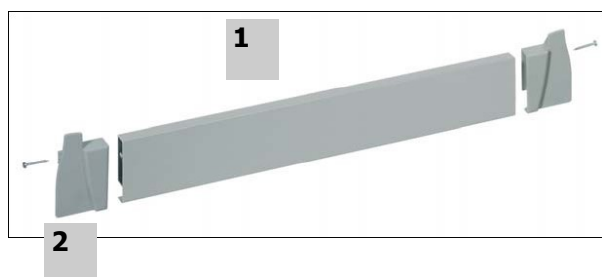

1 Tot corpus breedte 1200 mm. **30 B38018**

2 Fronthouder. **30 B38017**

Voor andere breedtes profiel inkorten op binnenmaat kast - 90 mm.



1 Tot corpus breedte 1200 mm. **30 B38018**

Voor andere breedtes profiel inkorten op binnenmaat kast - **90 mm**.

2 Buis lengte 1087 mm. **30 B38120**

Voor andere breedtes buis inkorten op binnenmaat kast - **80 mm**.

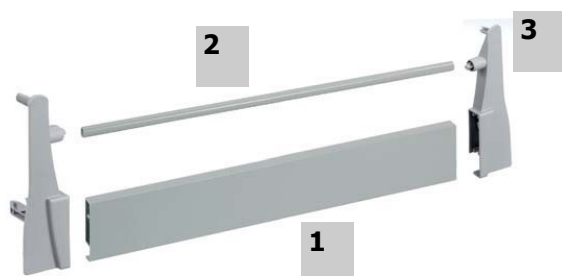

3 Fronthouder hoog. **30 B38019**

DWD Dwarsverdeling OPTIMAL

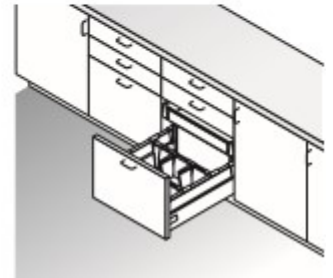
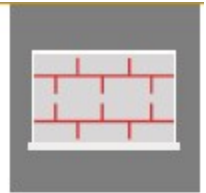

CODE

- | | |
|----------------------------|------------------|
| 1 profiel grijs, l 1072 mm | 30 B38125 |
| 2 Profielhouder grijs | 30 B38126 |
| 3 Smart board | 30 B38127 |

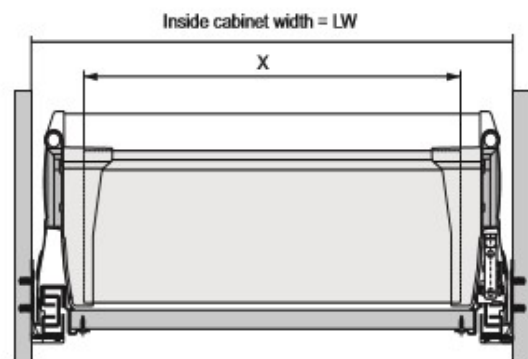
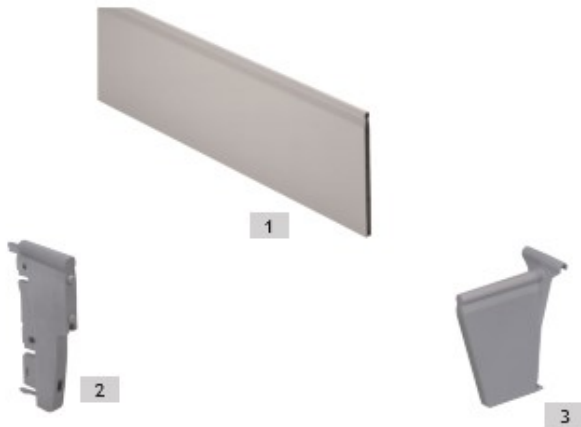

Optima profile for Duowing X = LW - 96

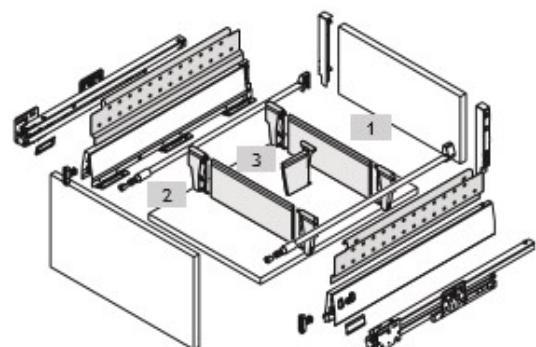

DWD Magic Sorto set

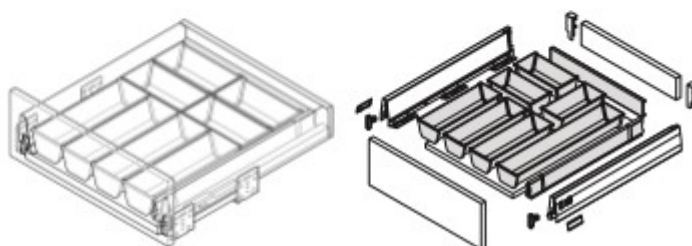

Voor lade diepte 500 mm



Magic sorto 1

30 B38150

Bestaande uit:
4 schalen 270 x 90 mm
4 schalen 180 x 90 mm
2 afstandhouder 180 mm
1 lade verdeler



Magic sorto 2

30 B38151

Bestaande uit:
1 schaal 450 x 90 mm met deksel
3 schalen 270 x 90 mm
3 schalen 180 x 90 mm
2 afstandhouder 180 mm
1 lade verdeler

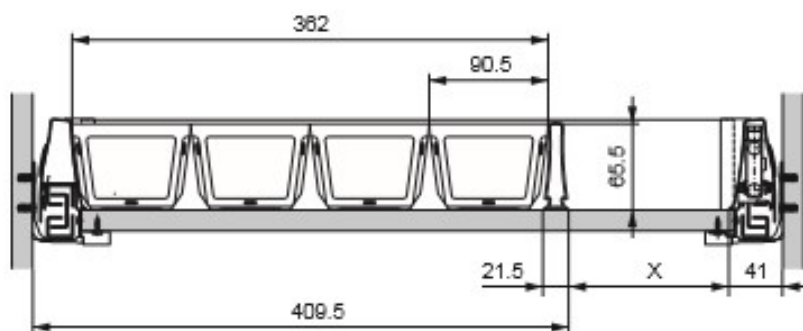

DWD Spoelbakkade

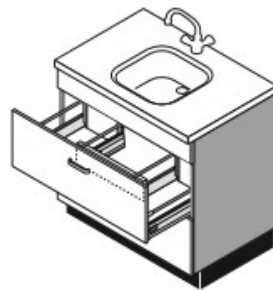

Spoelbakkade

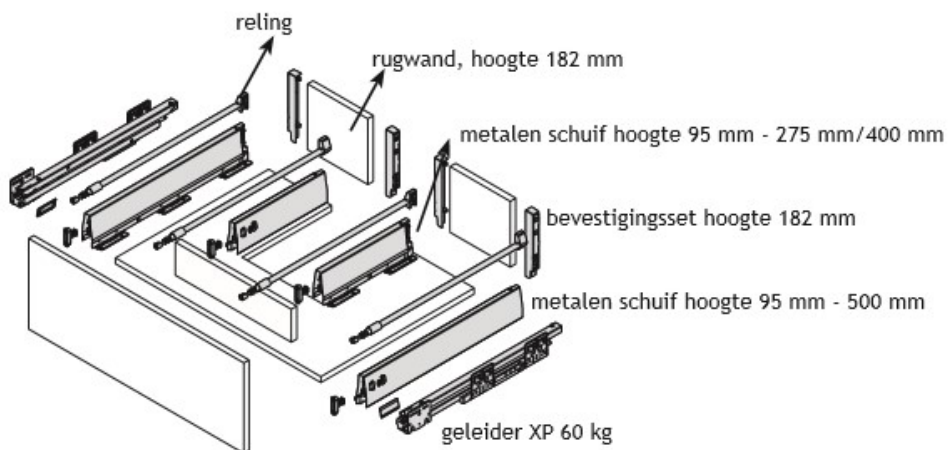

Afstandset

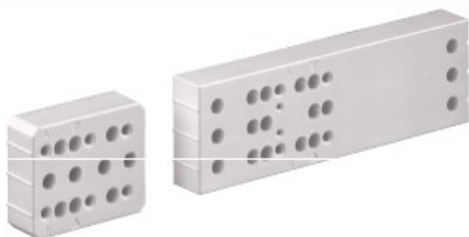

Grijs **30 B381410**

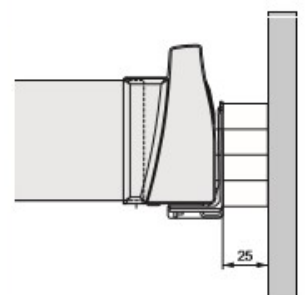
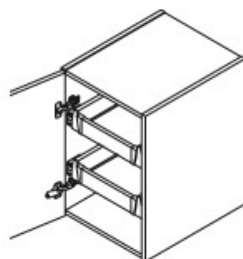

Lade Montage hulpmiddelen

Boormal voor frontbevestiging van de DWD XP lade



30 B38203

Boormal voor het korpusgedeelte voor DWP XP lade



30 B38201

Afpuntset voor DWP XP lade



30 B38200

Boormal voor de frontbevestiging de reling van DWP XP lade



30 B38204

Inslagtempel voor frontbevestiging met drevel van DWP XP lade



30 B38202

Lade Bestekindeling



| OMSCHRIJVING | BREEDTE | KORPUS | CODE |
|--|---------------------------------|------------------|-----------|
| FLEXYTRAY | <i>Flexytray Classic</i> | | |
| Deze bestekindeling kan rondom ingekort worden met een cirkelzaag. | 305..340 mm | 40 cm | 5102-2040 |
| | 355..390 mm | 45 cm | 5102-2045 |
| | 405..440 mm | 50 cm | 5102-2050 |
| | 455..490 mm | 55 cm | 5102-2055 |
| | 505..540 mm | 60 cm | 5102-2060 |
| | 705..750 mm | 80 cm | 5102-2080 |
| | 805..850 mm | 90 cm | 5102-2090 |
| | 905..921 mm | 100 cm | 5102-2098 |
| | 1105..1150 mm | 120 cm | 5102-2099 |
| | Uitvoering: kunststof Antraciet | <i>Flexytray</i> | |
| 505..540 mm | | 60 cm | 5102-2160 |
| 805..850 mm | | 90 cm | 5102-2190 |
| | 905..921 mm | 100 cm | 5102-2199 |
| Extra te bestellen | | | |
| Vakverdeler Flexytray Classic | | | 5102-2000 |
| Vakverdeler Flexytray | | | 5102-2100 |

FLEXYTRAY CLASSIC

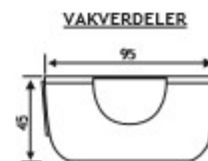
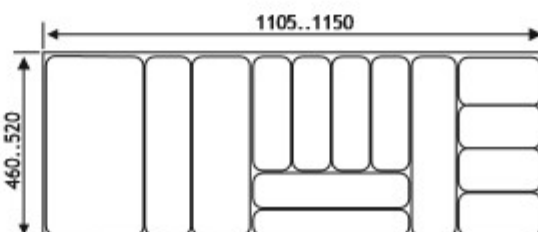
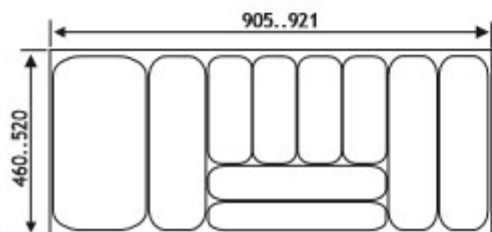
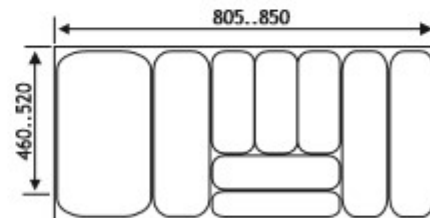
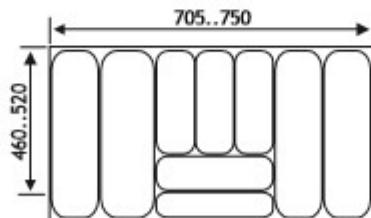
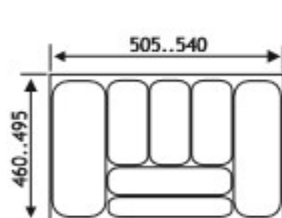
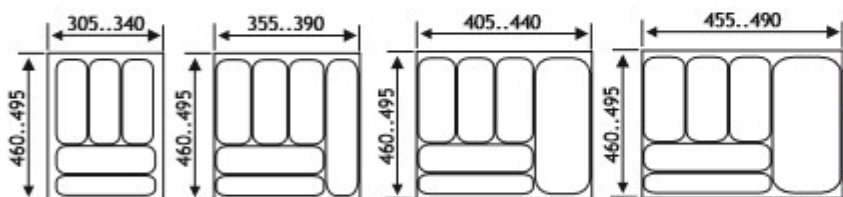

Geleider Dynapro voor houten lades met softclose 40 kg

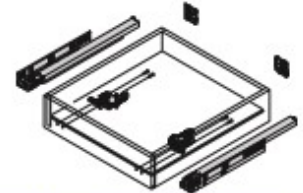
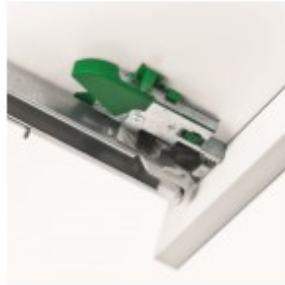

GELEIDER DYNAPRO VOOR HOUTEN LADES DRAAGKRACHT 40 KG VOLLEDIG UITTREKBAAR MET SOFT-CLOSE



- regelbare hoogteverstelling + 3,5 mm
- regelbare zijdeverstelling +/- 1,5 mm
- frontverstelling + 4 mm

| Diepte mm | code |
|-----------|------------------|
| 300 | 30 C10441 |
| 350 | 30 C10442 |
| 400 | 30 C10443 |
| 450 | 30 C10444 |
| 500 | 30 C10445 |
| 550 | 30 C10446 |
| 600 | 30 C10459 |

Extra te bestellen
 3D koppeling en versteladapter 30 C10975
 2D koppeling en versteladapter 30 C10976

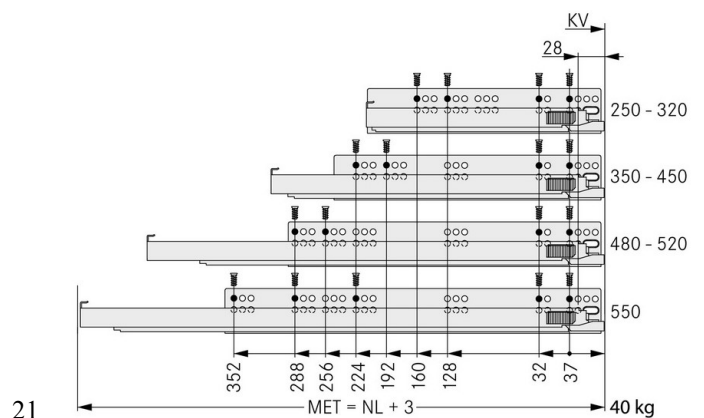
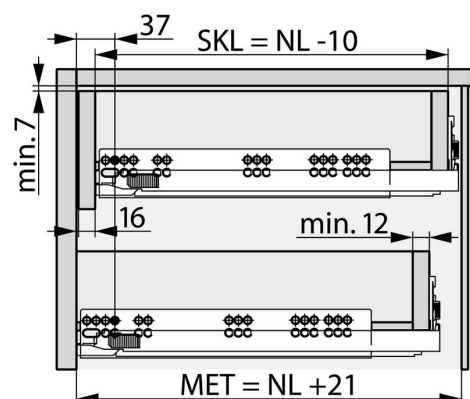
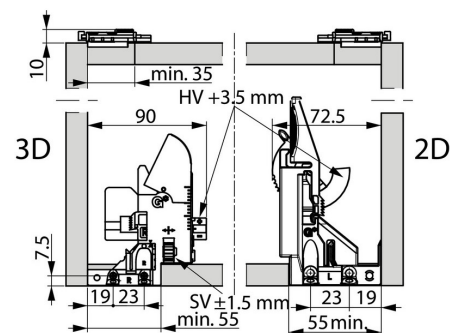
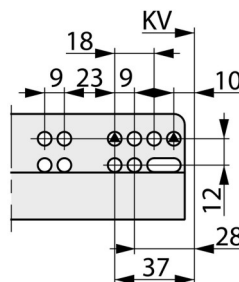
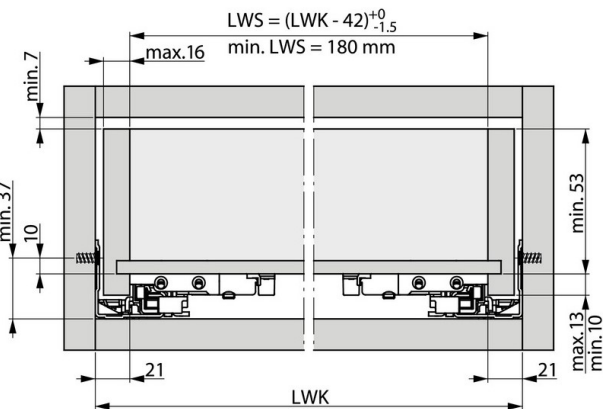

Geleider Dynapro voor houten lades met softclose 60 kg



60 kg

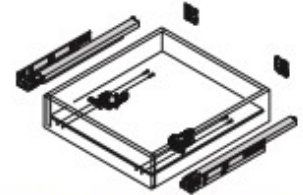

GELEIDER DYNAPRO VOOR HOUTEN LADES DRAAGKRACHT 60 KG VOLLEDIG UITTREKBAAR MET SOFT-CLOSE.

| Diepte mm | code |
|-----------|------------------|
| 450 | 30 C10470 |
| 500 | 30 C10471 |
| 550 | 30 C10472 |
| 580 | 30 C10476 |
| 600 | 30 C10473 |
| 650 | 30 C10474 |
| 700 | 30 C10477 |
| 750 | 30 C10478 |



- regelbare hoogteverstelling + 3,5 mm
- regelbare zijdeverstelling +/- 1,5 mm
- frontverstelling + 4 mm

Extra te bestellen
3D koppeling en versteladapter
2D koppeling en versteladapter

30 C10975
30 C10976

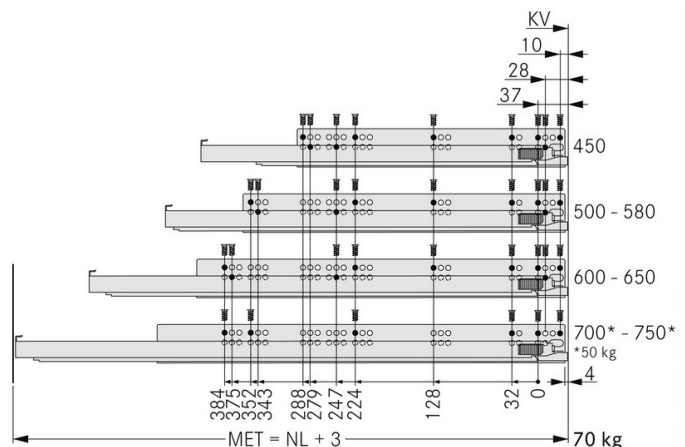
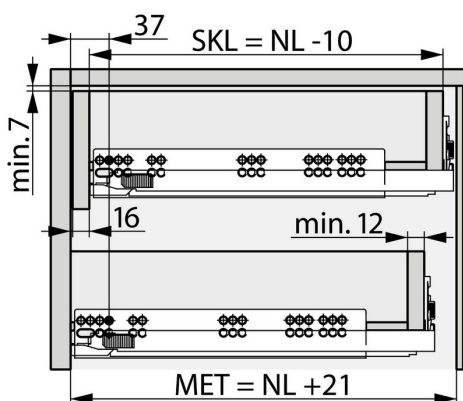
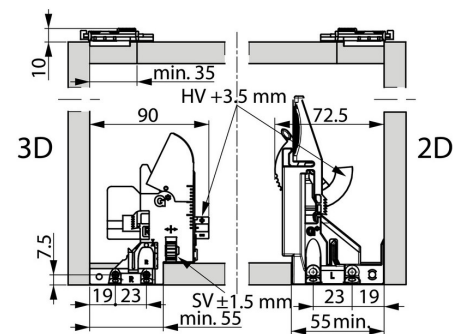
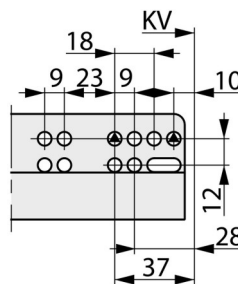
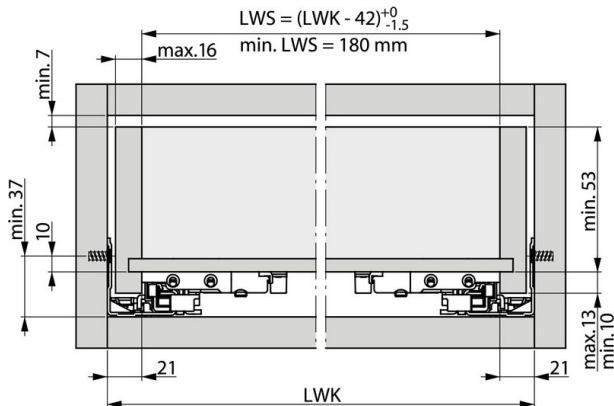

Geleider Dynapro voor houten lades Tipmatic 40/60 kg

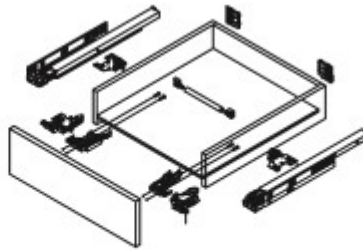

**GELEIDER DYNAPRO VOOR HOUTEN LADES
DRAAGKRACHT 40/60 KG VOLLEDIG UITTREKBAAR
MET GEÏNTEGREERDE TIPMATIC.**



| | 40 kg. | 60 kg. |
|--------|-----------|-----------|
| 300 mm | 5300-0330 | |
| 350 mm | 5300-0335 | |
| 400 mm | 5300-0340 | |
| 450 mm | 5300-0345 | 5300-0445 |
| 500 mm | 5300-0350 | 5300-0450 |
| 550 mm | 5300-0355 | 5300-0455 |
| 600 mm | | 5300-0460 |
| 650 mm | | 5300-0465 |
| 700 mm | | 5300-0470 |
| 750 mm | | 5300-0475 |

* draagkracht: max. 50 kg.

Extra te bestellen
3D koppeling en versteladapter 30 C10975
2D koppeling en versteladapter 30 C10976
Dynapro Tipmatic synchronisatieset 40 kg. 5300-0300
Dynapro Tipmatic synchronisatieset 60 kg. 5300-0400
verbindingstang 30 B38089

Dynapro Tipmatic synchronisatieset

Verbindingstang



- regelbare hoogverstelling + 3,5 mm
- regelbare zijdeverstelling +/- 1,5 mm
- regelbare hoekverstelling + 4 mm
- frontverstelling + 1,5 mm

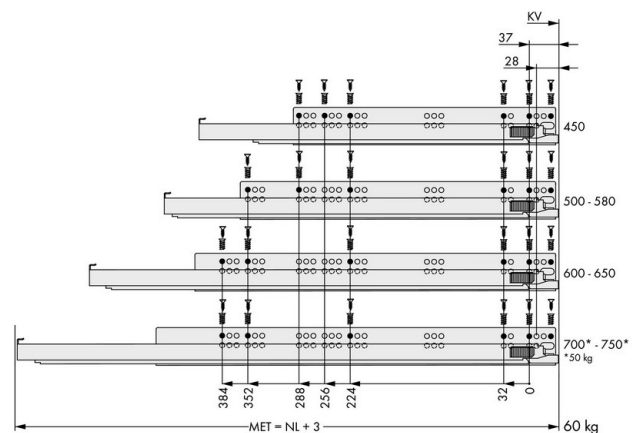
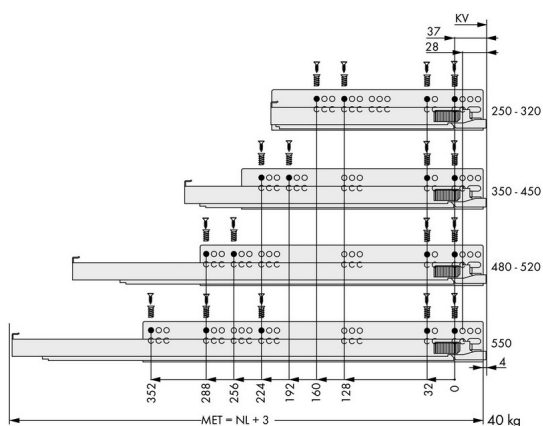
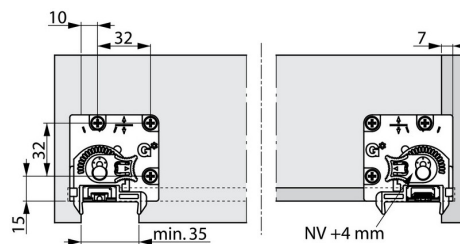
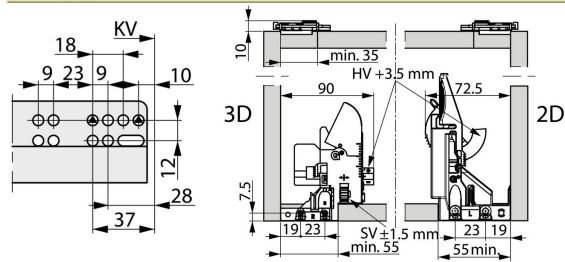

Rolgeleiders

GELEIDER AL 1700

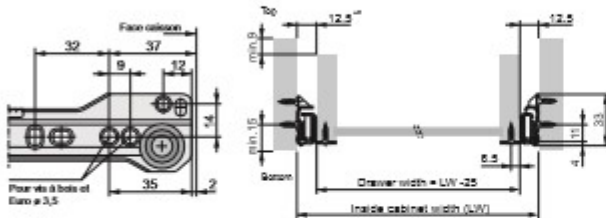

Zelfsluitende
bodembevestiging

Draagkracht: max.: 30 kg.

G*GRASS®

LENGTE

CODE

| | |
|-------|------------------|
| | <u>crème-wit</u> |
| 25 cm | 5244-2025 |
| 35 cm | 5244-2035 |
| 40 cm | 5244-2040 |
| 45 cm | 5244-2045 |
| 50 cm | 5244-2050 |
| 55 cm | 5244-2055 |

TELESCOPISCHE GELEIDER AL 5300



Zelfsluitende
bodembevestiging

Draagkracht: max.: 50 kg.

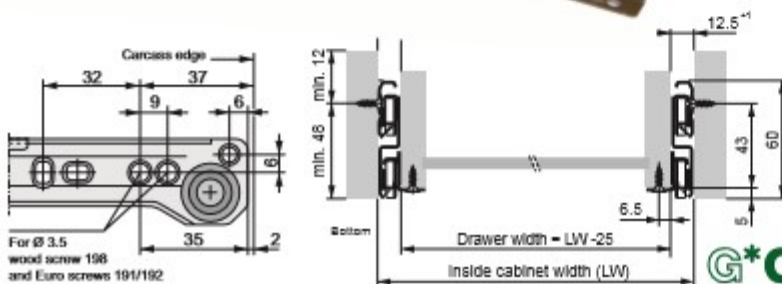

G*GRASS®

LENGTE

CODE

| | | |
|-------|--------------|--------------|
| | <u>crème</u> | <u>bruin</u> |
| 25 cm | 5244-2125 | 5244-2225 |
| 30 cm | 5244-2130 | 5244-2230 |
| 35 cm | 5244-2135 | 5244-2235 |
| 40 cm | 5244-2140 | 5244-2240 |
| 45 cm | 5244-2145 | 5244-2245 |
| 50 cm | 5244-2150 | 5244-2250 |
| 55 cm | 5244-2155 | 5244-2255 |
| 60 cm | 5244-2160 | 5244-2260 |
| 65 cm | 5244-2165 | |
| 70 cm | 5244-2170 | |
| 75 cm | 5244-2175 | |
| 80 cm | 5244-2180 | |

Kogelgeleiders

Kogelgeleider vol. uittrekbaar 45 kg

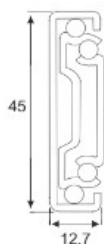

BBS 45

Kugelkäfigvollauszug nach DIN 68 858, zur seitlichen Montage

Full extension ball bearing slide, DIN 68 858, for side mounted installation

Tragkraft 45 kg (bei Länge 450mm)

Load capacity 45kg (for 450mm length)

32mm Lochbild / Bore hole system

Trennbar über Hebel / Detachable by clip

Teleskopauszug / Telescopic extension

Material: Stahl, verzinkt / Steel, zinc plated

10 Paar / Pairs

Min.Korpustiefe

| Min. Cabinet depth | Art. No. |
|--------------------|----------|
| 250mm | 4527.250 |
| 300mm | 4527.300 |
| 350mm | 4527.350 |
| 400mm | 4527.400 |
| 450mm | 4527.450 |
| 500mm | 4527.500 |
| 550mm | 4527.550 |
| 600mm | 4527.600 |
| 650mm | 4527.650 |
| 700mm | 4527.700 |

Kogelgeleider vol. uittrekbaar 60 kg

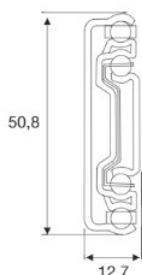

BBS 60

Kugelkäfigvollauszug zur seitlichen Montage

Full extension ball bearing slide, for side mounted installation

Tragkraft 60 kg (bei Länge 450mm)

Load capacity 60 kg (for 450mm length)

32mm Lochbild / Bore hole system

Trennbar über Hebel / Detachable by clip

Teleskopauszug / Telescopic extension

Material: Stahl, verzinkt / Steel, zinc plated

10 Paar / Pairs

Min.Korpustiefe

| Min. Cabinet depth | Art. No. |
|--------------------|----------|
| 305mm (12") | 4528.300 |
| 355mm (14") | 4528.350 |
| 405mm (16") | 4528.400 |
| 455mm (18") | 4528.450 |
| 510mm (20") | 4528.500 |
| 560mm (22") | 4528.550 |
| 610mm (24") | 4528.600 |
| 660mm (26") | 4528.650 |
| 710mm (28") | 4528.700 |

Kogelgeleiders

Kogelgeleider vol. uittrekbaar 90 kg

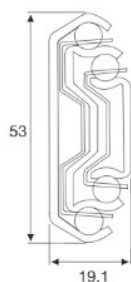

Schubladen können durch Bedienung des Trennschiebers ausgehängt werden.
Drawers can be detached by pressing the lever.

BBS 90

Kugelkäfigvollauszug zur seitlichen Montage

Full extension ball bearing slide, for side mounted installation

Tragkraft 90 kg (bei Länge 450mm)
Load capacity 90kg (for 450mm length)

Trennbar über Hebel / Detachable by clip

Teleskopauszug / Telescopic extension

Material: Stahl, verzinkt / Steel, zinc plated

6 Paar / Pairs

Min.Korpustiefe

| Min. Cabinet depth | Art. No. |
|--------------------|----------|
| 305mm (12") | 4532.300 |
| 355mm (14") | 4532.350 |
| 405mm (16") | 4532.400 |
| 455mm (18") | 4532.450 |
| 510mm (20") | 4532.500 |
| 560mm (22") | 4532.550 |
| 610mm (24") | 4532.600 |
| 660mm (26") | 4532.650 |
| 710mm (28") | 4532.700 |

Weitere Längen auf Anfrage lieferbar
Further lengths available upon request

Kogelgeleider vol. uittrekbaar 160 kg

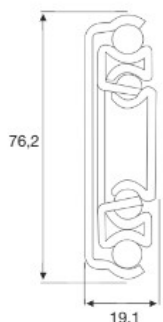

BBS 160

Kugelkäfigvollauszug zur seitlichen Montage

Full extension ball bearing slide, for side mounted installation, guided by 2 ball cages

Tragkraft 160 kg (bei Länge 450mm)
Load capacity 160 kg (for 450mm length)

Nicht trennbar / Not detachable

Teleskopauszug / Telescopic extension

Material: Stahl, verzinkt / Steel, zinc plated

4 Paar / Pairs

Min.Korpustiefe

| Min. Cabinet depth | Art. No. |
|--------------------|----------|
| 305mm (12") | 4537.300 |
| 355mm (14") | 4537.350 |
| 405mm (16") | 4537.400 |
| 455mm (18") | 4537.450 |
| 510mm (20") | 4537.500 |
| 560mm (22") | 4537.550 |
| 610mm (24") | 4537.600 |
| 660mm (26") | 4537.650 |
| 710mm (28") | 4537.700 |

Weitere Längen bis max. 1200mm auf Anfrage lieferbar
Further lengths up to 1200 mm available upon request

GELEIDER VOOR UITTREKKASTEN SERIE 059 MET DEMPING



- Volledig uittrekbaar.
- Boven- en ondergeleider.
- Winkelhaak met frontregeling.
- Damping systeem "Soft Control" 50 mm.
- Uitvoering: gegalvaniseerd staal.
- Draagkracht: 120 kg.

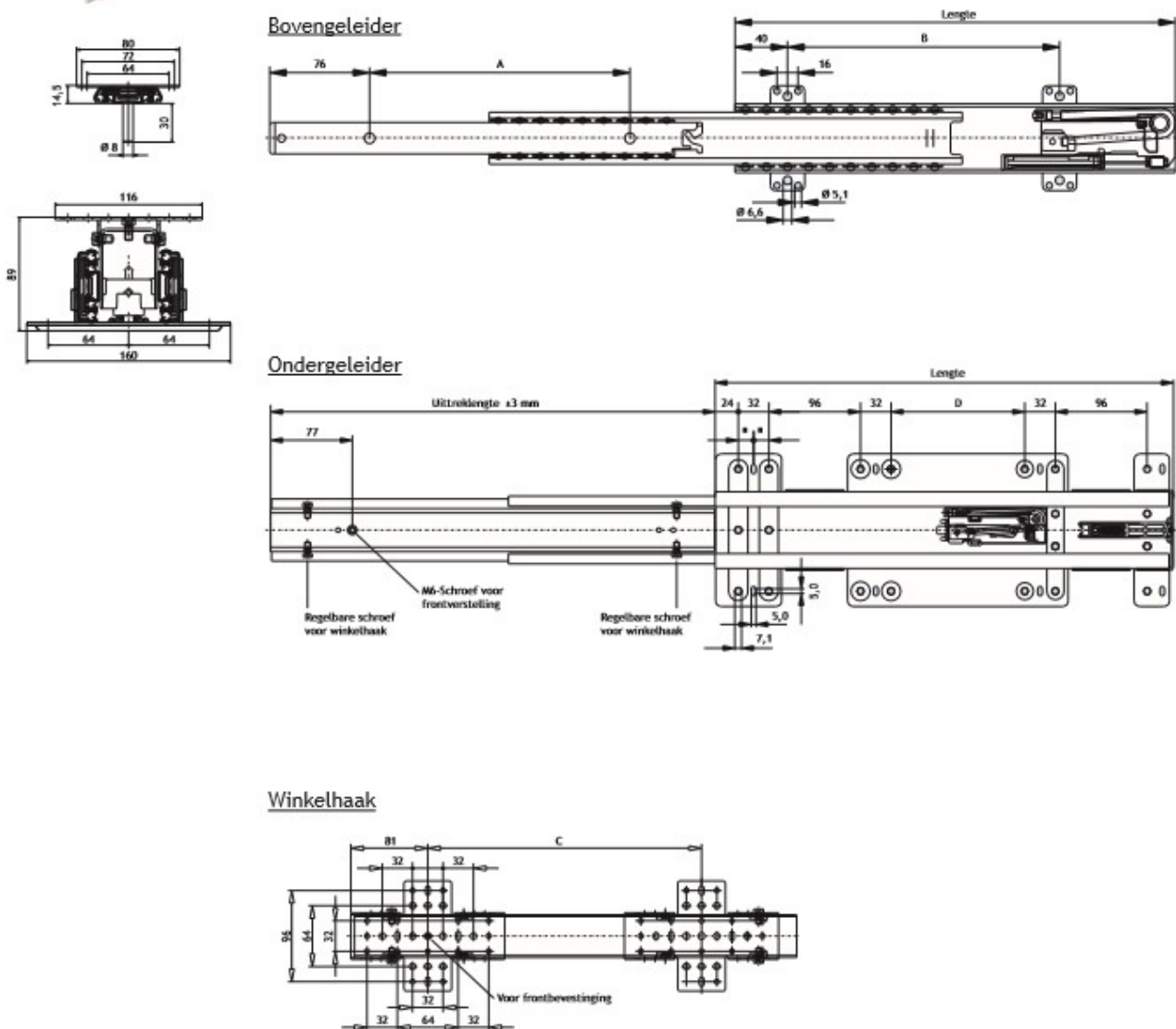

| Lengte mm | Uittreklengte mm | Draagkracht per paar (kg) bij 50000 cycles | A mm | B mm | C mm | D mm | Gewicht kg/paar | Code |
|--------------|---------------------|---|---------|---------|---------|---------|--------------------|-----------|
| 450 | 435 | 120 | 288 | 352 | 256 | 110 | 6,30 | 5244-5845 |
| 480 | 465 | 120 | 320 | 352 | 288 | 140 | 6,63 | 5244-5848 |
| 600 | 585 | 120 | 416 | 416 | 416 | 260 | 8,25 | 5244-5860 |

GELEIDER VOOR TOETSENBORD SERIE 043



- Volledig uittrekbaar.
- Positieve stop in gesloten positie.
- Uitvoering: gegalvaniseerd staal.

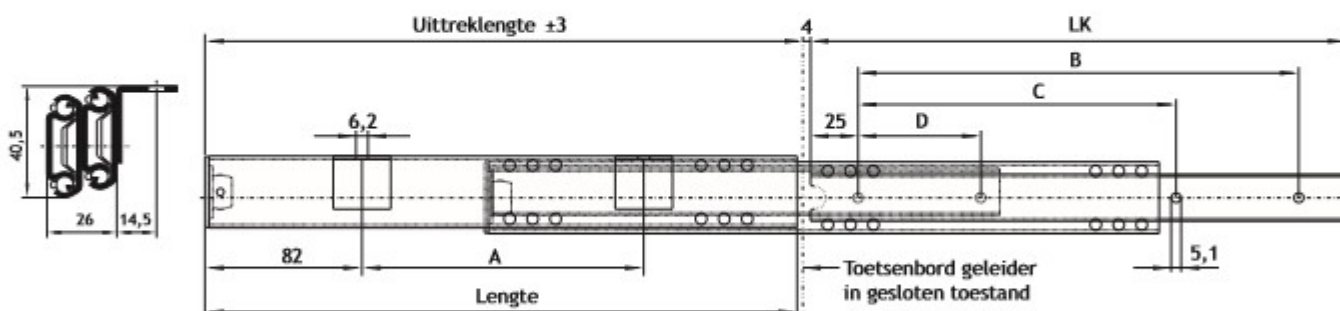

| Lengte mm | Uittreklengte mm | Draagkracht per paar (kg) bij 100000 cycles | LK mm | A mm | B mm | C mm | D mm | Gewicht kg/paar | Code |
|--------------|---------------------|--|----------|---------|---------|---------|---------|--------------------|-----------|
| 377 | 380 | 55 | 280 | 215 | 230 | 166 | 64 | 2,02 | 5244-5838 |

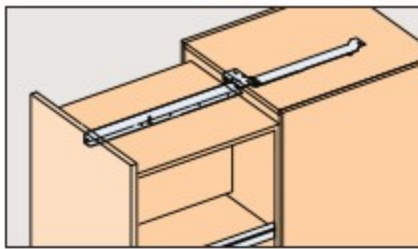



EKU-FORTE 170/340

Uittreksysteem voor hoge kasten voor bodemmontage. Ideaal voor houten maatkasten.

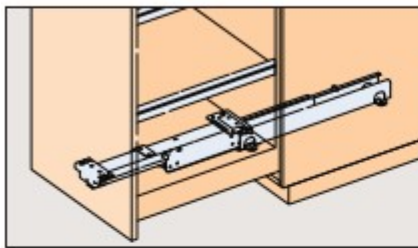
- **Maximum inbouwmaten:**
binnenhoogte: 2400 mm
binnenbreedte: 600 mm (1 geleider)
binnenbreedte: 800 mm (2 geleiders)
- **Rolsysteem:** differentiaalgeleider uitgerust met kunststofmannelde wieltjes die een geruisloze loop garanderen, met bovengeleiding.
- **Max. draagkracht:** 170kg. / 340kg Met 2 geleiders en een verbindingsset (apart te bestellen)
- **Kleur:** lichtgrijs (RAL 7035)
- **Hoogteregeling** + 2 mm voor het perfect regelen van het frontpaneel.

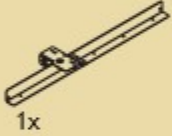
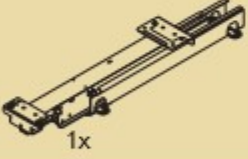
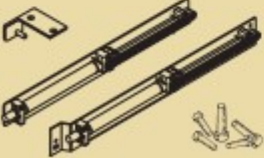

| | OMSCHRIJVING | LENGTE (LT) | UITGETROKKEN LENGTE (LA) | A | CODE |
|---|---------------------------|-------------|--------------------------|-----------|-----------|
|  1x  1x | Garnituur Forte 170/340 | 385 mm* | 380 mm | 300 mm | 5662-2938 |
| | | 435 mm | 430 mm | 350 mm | 5662-2943 |
| | | 485 mm | 480 mm | 400 mm | 5662-2948 |
| | | 535 mm | 530 mm | 450 mm | 5662-2953 |
| | | 585 mm | 580 mm | 500 mm | 5662-2958 |
| | | 635 mm | 630 mm | 550 mm | 5662-2963 |
| | | 685 mm | 680 mm | 600 mm | 5662-2968 |
| | | 785 mm | 780 mm | 700 mm | 5662-2978 |
| | | 885 mm | 880 mm | 800 mm | 5662-2988 |
| | | 985 mm | 980 mm | 900 mm | 5662-2998 |
| | 1085 mm | 1080 mm | 1000 mm | 5662-2999 | |
| | * kan niet gedempt worden | | | | |
| | Min. 1 set | | | | |
| TOEBEHOREN | OMSCHRIJVING | | | | CODE |
|  | Dempingset | | | | 5662-3010 |
| | Min. 1 set | | | | |
|  | Verbindingsset | | | | 5662-2010 |
| | Min. 1 set | | | | |

Montagevoorbeelden

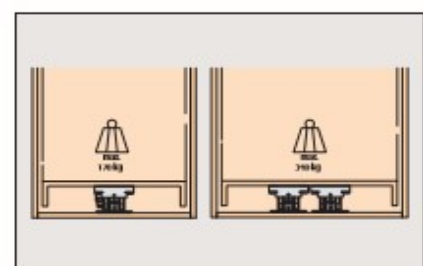
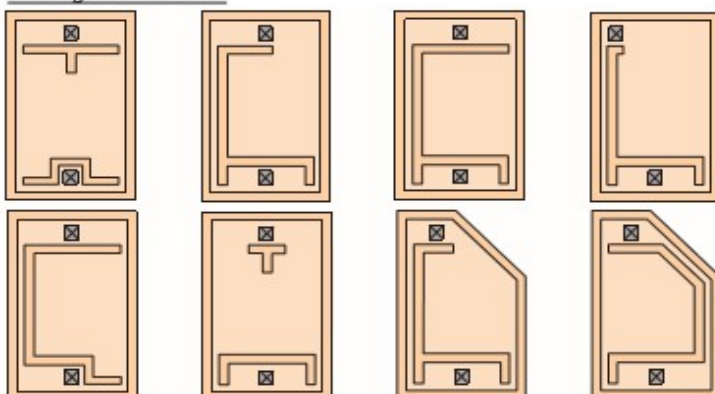

Gemakkelijk uittrekbaar tot 170 of 340 kg.

Verkoop- en leveringsvoorwaarden

offertes

Alle offertes zijn voor wat betreft prijs, leveringstijden en mogelijkheid van levering, vrijblijvend.

levering

a) Levering geschiedt af fabriek of af magazijn van de verkoper; alle goederen reizen voor rekening en risico van de koper, ook wanneer de verzending franco geschiedt.

b) De verkoper neemt geen enkele aansprakelijkheid op zich voor de gevolgen van vertraagde levering.

c) Alle gevallen van bedrijfsmoeilijkheden en overmacht in de ruimste zin, geven de verkoper het recht de opdracht te annuleren of de levertijd te verlengen zonder verplichting van nalevering en/of schadevergoeding.

d) Alle leveringen beneden de e 250,- geschieden niet franco.

e) Extra vrachtkosten ontstaan door stremming van scheepvaart-, auto- of spoorwegdiensten, door snel- of expresse-verzending of doordat op verzoek van de koper de verzending plaats heeft op andere wijze dan gebruikelijk is, komen voor rekening van de koper.

reklames

a) Reklames moeten uiterlijk 8 dagen na ontvangst van de factuur, schriftelijk, aangetekend, worden ingediend. Na die datum hebben reclames geen recht meer op erkenning. Ook worden geen reclames erkend indien het geleverde op enigerlei wijze verwerkt is.

b) Reklames of meningsverschillen van welke aard ook geven de koper geen recht tot uitstel van betaling.

aansprakelijkheid

De verkoper is nimmer aansprakelijk voor indirecte schade, daaronder begrepen gevolgschade. Gederfde winst, gemiste besparingen en schade door bedrijfsstagnatie.

betaling en incassokosten

a) Betaling dient te geschieden uiterlijk 30 dagen na factuurdatum zonder korting, of binnen 14 dagen onder aftrek van de kredietbeperking.

b) Is niet binnen 30 dagen na factuurdatum betaald, dan is de koper een rente verschuldigd van 1% per maand.

c) Alle incassokosten, gerechtelijke zowel als buitengerechtelijke, waaronder ook die, verbonden aan een eventuele faillissementsaanvraag, komen ten laste van de koper. Indien de incasso door de verkoper wordt opgedragen aan een derden zullen de incassokosten minimaal 15% van de hoofdsom en de verpagingsrente bedragen.

eigendomsvoorbehoud

a) Tot aan de volledige voldoening van alle vorderingen welke voor de verkoper uit de koopovereenkomst voortvloeien, blijven de geleverde goederen het uitsluitend eigendom van de verkoper en kunnen deze terstond door de verkoper worden teruggevorderd.

Dit eigendomsvoorbehoud laat slechts het recht van de koper om het materiaal aan zijn klanten door te verkopen of het in zijn eigenbedrijf te ver- of bewerken onverlet.

b) Indien de verkoper gebruik maakt van het in het voorgaande lid omschreven recht van terugvordering blijft de koper gehouden tot alle schadevergoeding die door wanbetaling mocht zijn ontstaan.

c) Indien koper aan zijn verplichtingen niet heeft voldaan, waaronder begrepen de toekomstige verplichtingen jegens verkoper, draagt koper aan verkoper over alle zich onder hem bevindende door verkoper geleverde goederen, danwel de goederen, welke door verkoper vertegenwoordigde fabrieken zijn geleverd, in eigendom over. Verkoper kan te allen tijde desgewenst de door hem geleverde goederen tot zekerheid terugvorderen, c.q. tot zich nemen.

administratiekosten

Bij een factuurbedrag van e 250,- of minder heeft de verkoper het recht administratiekosten van tenminste e 7,00 in rekening te brengen. Voorts zijn zij gerechtigd 2% administratie- en/of kredietbeperkingskosten in rekening te brengen.

afwijkingen

Afwijkingen van deze verkoopvoorwaarden zijn alleen van kracht indien deze afwijkingen door de verkoper schriftelijk zijn bevestigd.

afwijking in prijzen

Bevestigde en niet gefactureerde bestellingen worden bij wijzigingen in prijs volgens de nieuwe noteringen gefactureerd, waarbij de partij, in wiens nadeel de prijs veranderd wordt, het recht heeft de bestelling te annuleren. In geval van wijzigingen in de valutaverhoudingen kan de verkoper het contract, voor zover nog niet uitgevoerd, te allen tijde doen eindigen zonder tot vergoeding of naleving gehouden te zijn.

annulering van orders

Indien de koper een order annuleert is hij gehouden tot betaling van alle voor de uitvoering gemaakte kosten en voor schade wegens winstderving. Geschillen welke tussen partijen mochten rijzen dienen door de koper te worden voorgelegd aan de Rechter van de plaats waar de verkoper is gevestigd. De verkoper kan het geschil voorleggen te zijner keuze aan de Rechter, die bevoegd is ter plaatse van vestiging van de verkoper zelf of van de koper.

**Broutec Meubelbeslag, Rogge 3
7261 JA Ruurlo, KVK 09164919
Telefoon: 0573-454242 Fax: 0573-453999**

**email: info@broutec.nl
www.broutec.nl**

aanvulling

Goederen worden uitsluitend na akkoord bevinding door de Leverancier c.q. verkoper teruggenomen, mits franco; Tenzij hier voren anders is bepaald zijn voorts van toepassing de regelen welke Incoterms 1953 inhouden voor het beding "Ex Works".

Deze voorwaarden zijn Gedeponneerd ter Griffie van de KvK te Doetinchem.
Datum: 29 januari 2007